

Tube Bundles by Stellar Industrial Technologies

Configure a replacement U-Tube Bundle. Complete the following form using the guidelines provided. *Quality Construction, Low Cost*
 Please call for assistance (866) 890-4040 FAX (740) 654-7053

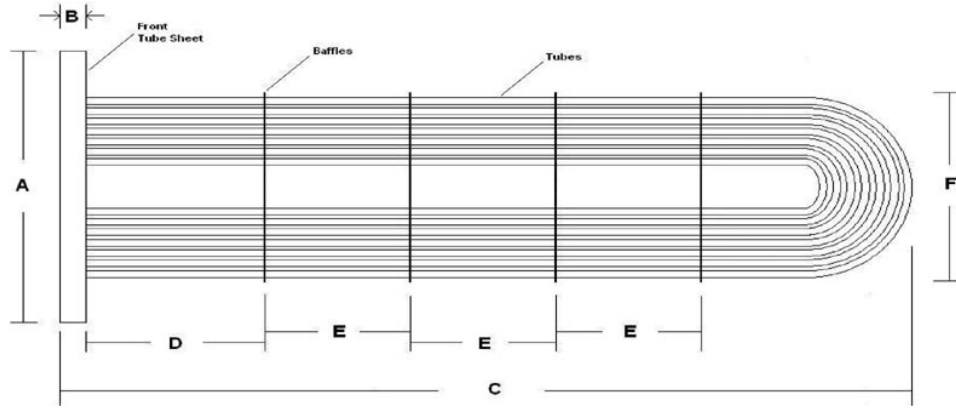
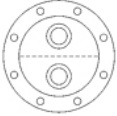
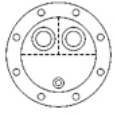
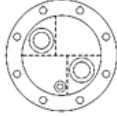

Number of Tubeside Passes				Enter # Passes
	2 Pass	4 Pass	6 Pass	

Tube Sheet Material	Carbon Steel	316 Stainless Steel
	Naval Brass	90/10 Cupro-Nickel
	304 Stainless Steel	Other

Number of Bolt Holes	Enter 0 for Boltless Tube
-----------------------------	---------------------------

Tube Diameter	3/8"	1/2"	3/4"	5/8"	1-1/4"	
----------------------	------	------	------	------	--------	--

Standard Tube Diameter: 3/4" OD

Tube Wall Thickness	.035	.049	.065	Other
----------------------------	------	------	------	-------

Standard Tube Wall Thickness: .049

Number of U-Tubes	
--------------------------	--



Name	
-------------	--

Company Name	
---------------------	--

Telephone		FAX	
------------------	--	------------	--

Email	
--------------	--

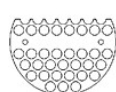
Your Reference for this Tube Bundle		
Manufacturer's Model # (if known)		
Manufacturer's Serial #		
Dimension A	Outside Diameter of the Tube Sheet:	
Dimension B	Thickness of the Tube Sheet:	
Dimension C	Overall Length of the Tube Bundle:	
Dimension D	Distance to the first baffle:	
Dimension E	Distance between the other baffles:	
Dimension F	Baffle Diameter:	

Baffle Cut Orientation			
	Full	Horizontal	Vertical
Baffles Material	No Preference	316 Stainless Steel	Number of Baffles
	Carbon Steel	90/10 Cupro-Nickel	
	Brass	304 Stainless Steel	

Bolt Hole Diameter "H"	
-------------------------------	--

Bolt Circle Chord "J"	
------------------------------	--

H = Center to center dimension of opposite bolt holes (Bolt Circle Diameter)

If this dimension can not be measured, find center to center of adjacent bolt holes, "J"

Additional Comments	
----------------------------	--

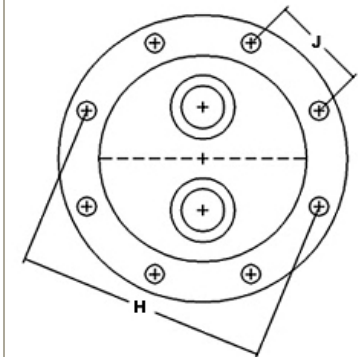

--